

	pas- en arm met kader, 54mm dik 60 min.brandw. naar binnendraaiend	Blad: 71
maten in mm		
okt. 2010		

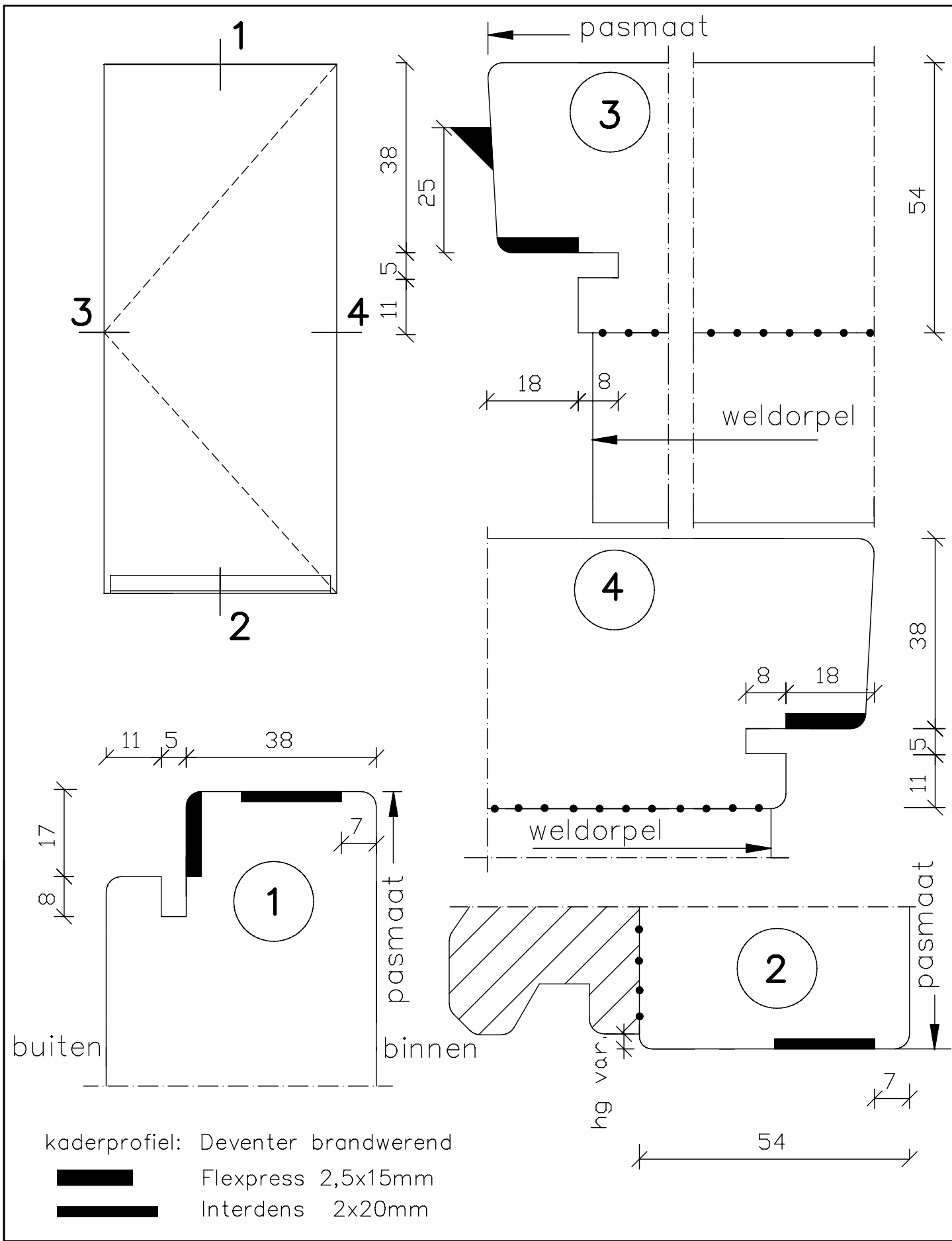

	pas- en arm met kader, 54mm dik 60 min.brandw. naar binnendraaiend	Blad: 71s
maten in mm okt. 2010		

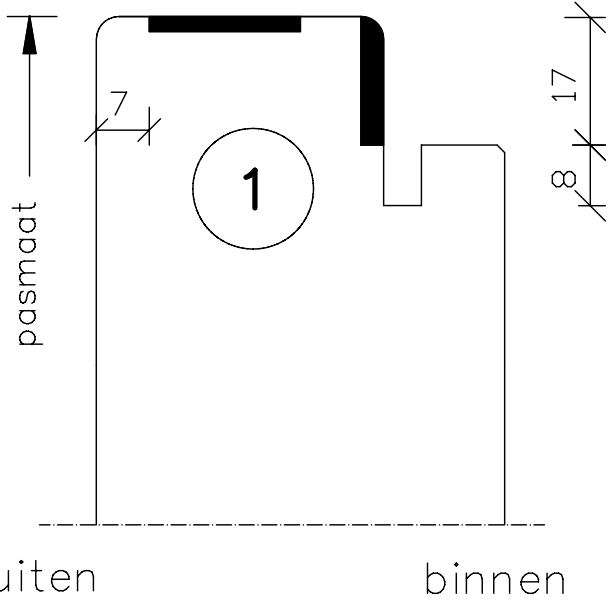
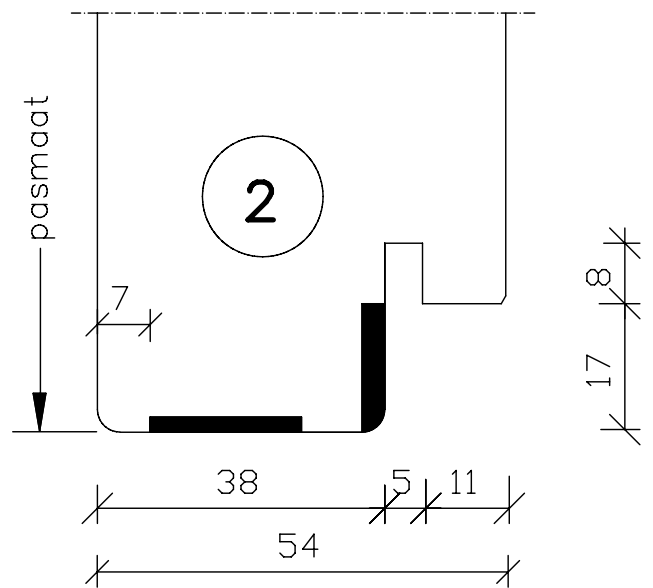
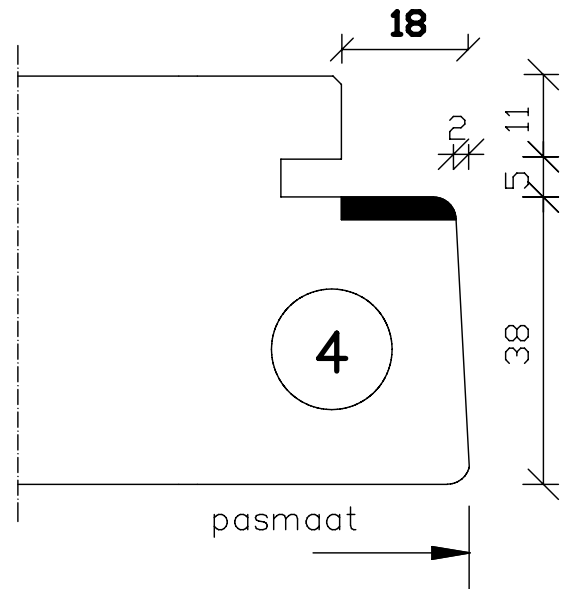
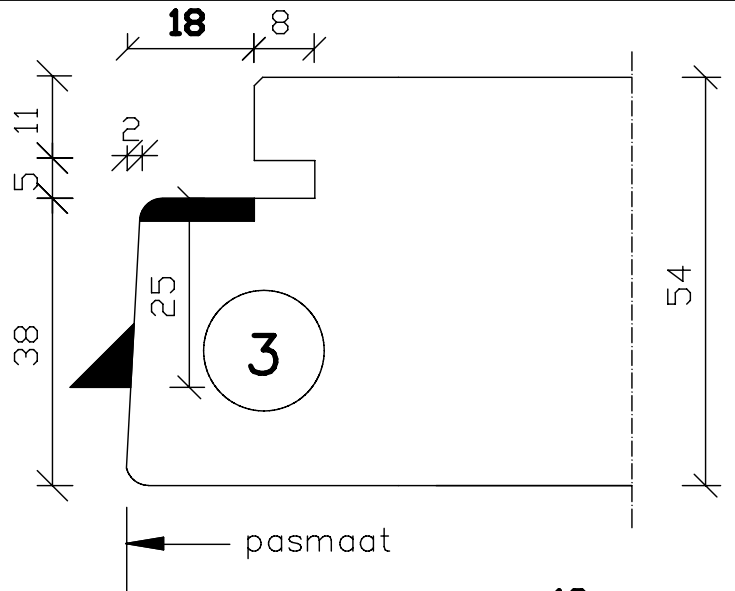
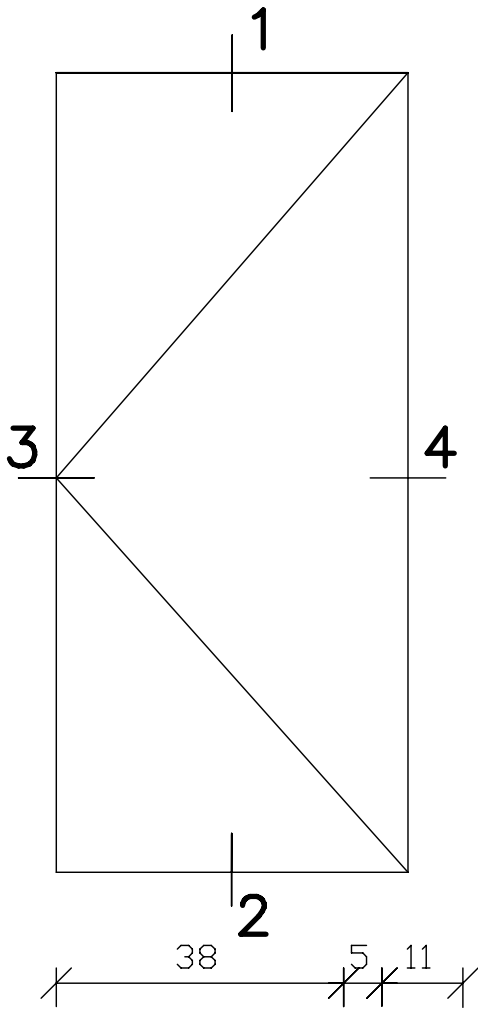

kaderprofiel: Deventer brandwerend
 Flexpress 2,5x15mm
 Interdens 2x20mm



	pas- en arm met kader, 54mm dik 60 min.brandw. naar buitendraaiend	Blad: 75
maten in mm		
okt. 2010		

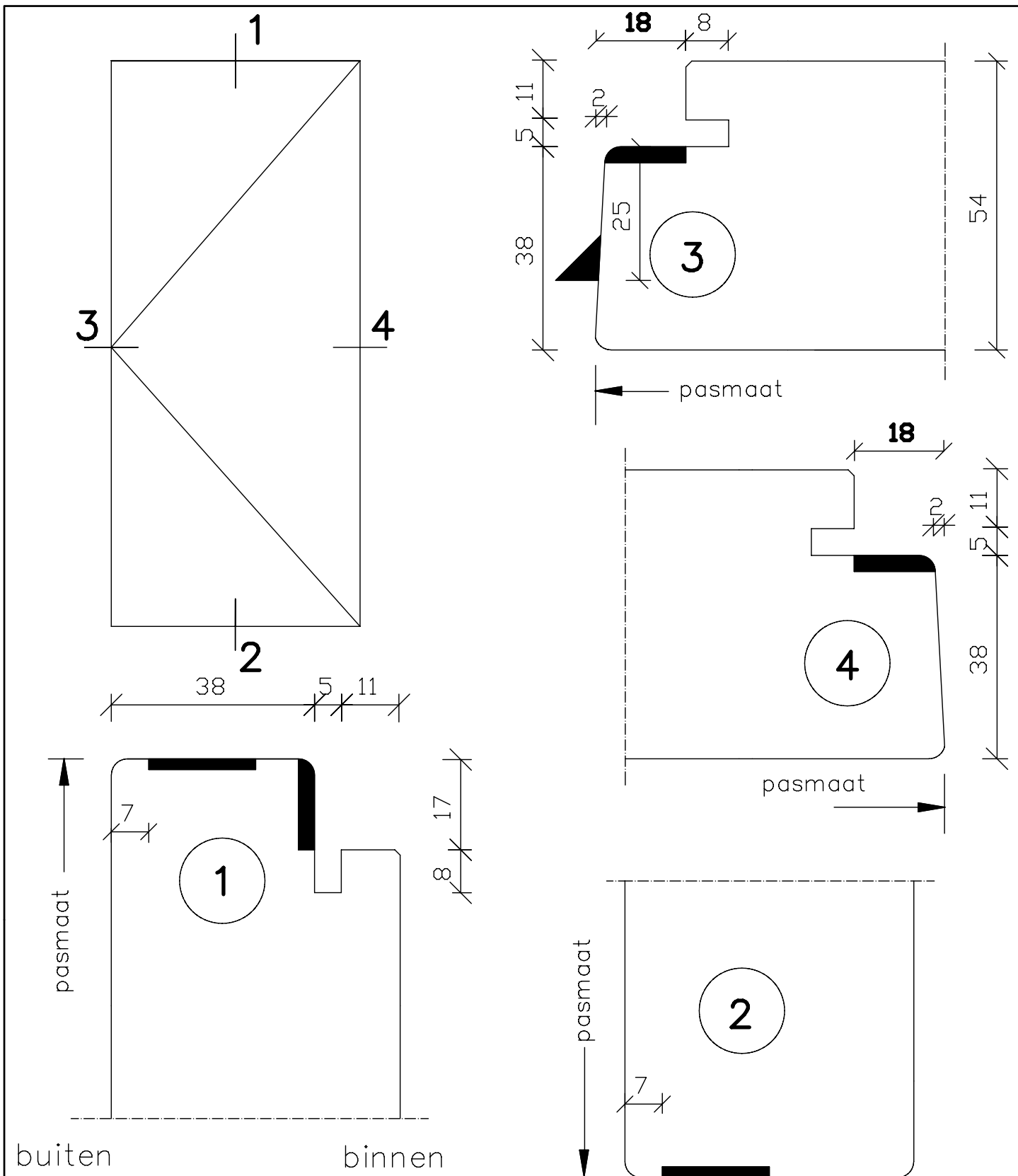

kaderprofiel: Deventer brandwerend
█ Flexpress 2,5x15mm
█ Interdens 2x20mm



	pas- en arm met kader, 54mm dik 60 min.brandw. naar buitendraaiend	Blad: 75s
maten in mm okt. 2010		

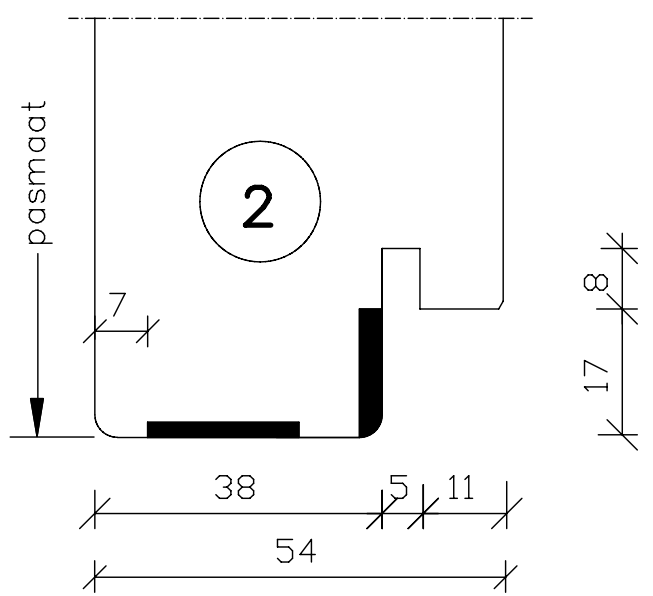
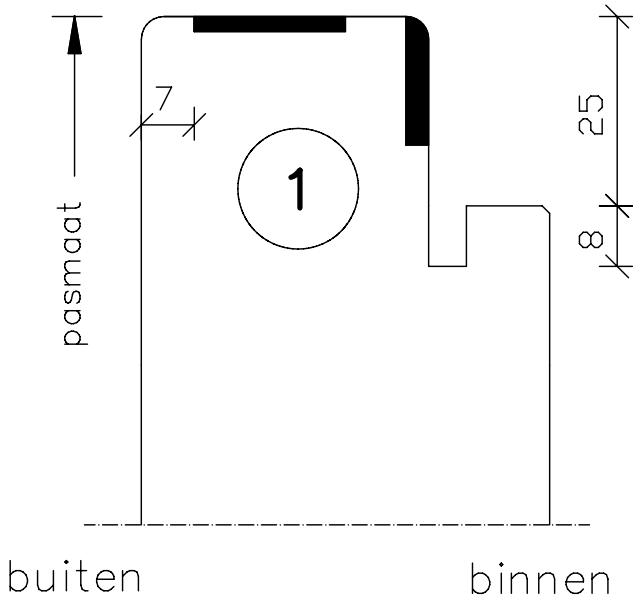
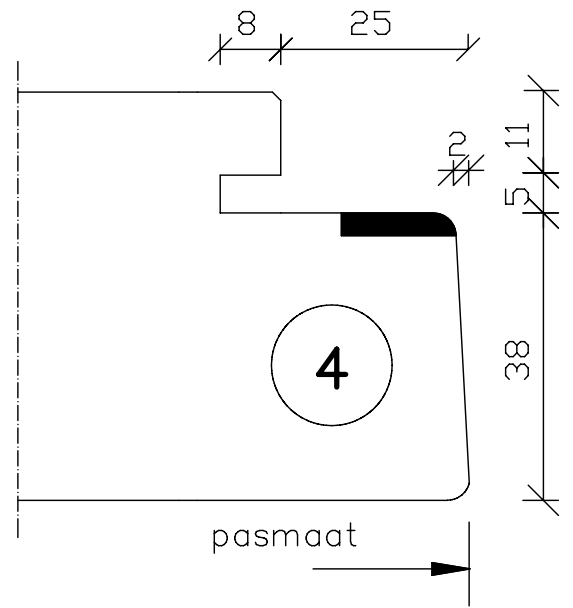
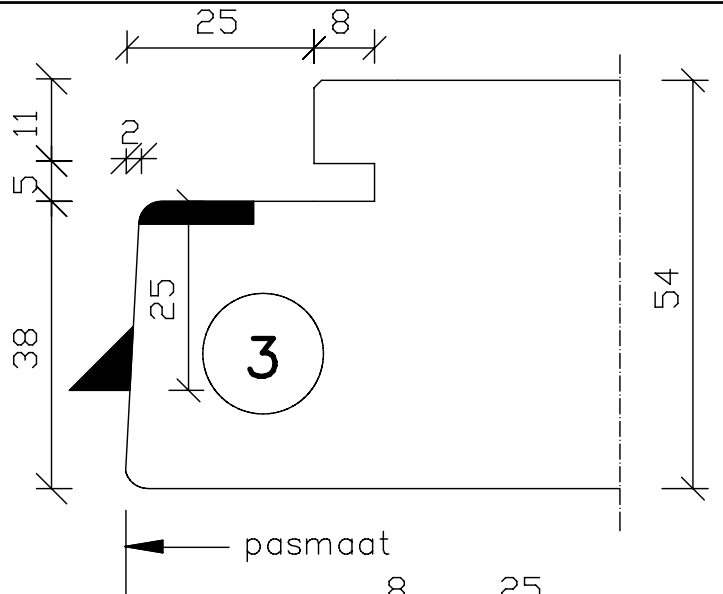
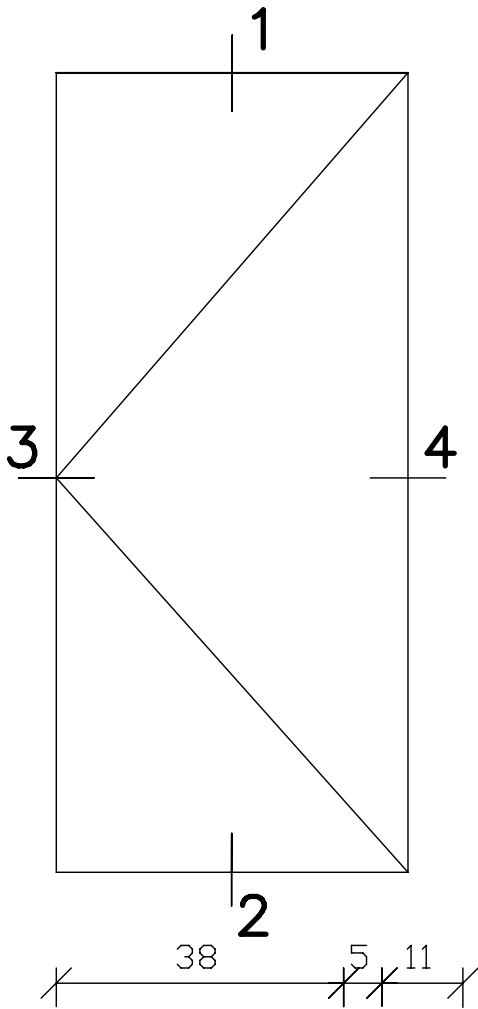

kaderprofiel: Deventer brandwerend

 Flexpress 2,5x15mm

 Interdens 2x20mm



maten in mm
okt. 2010

pas- en arm met kader, 54mm dik 60 min.brandw. naar buitendraaiend

Blad: 912

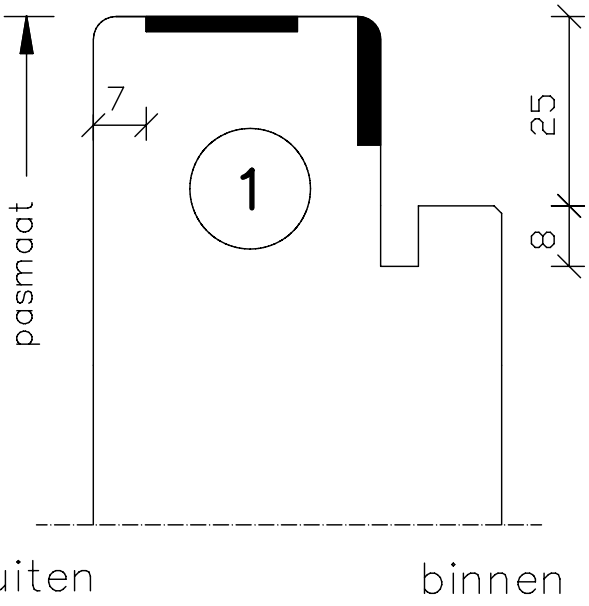
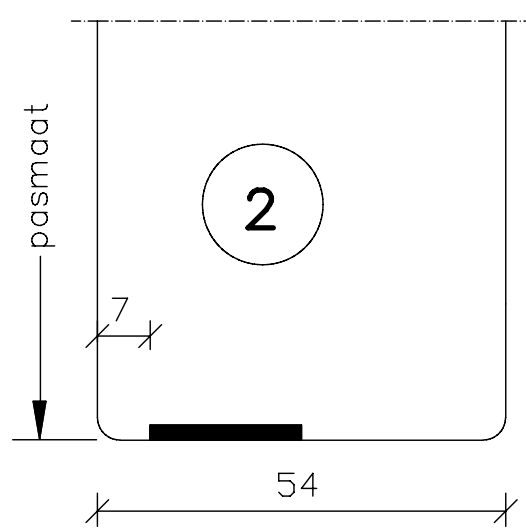
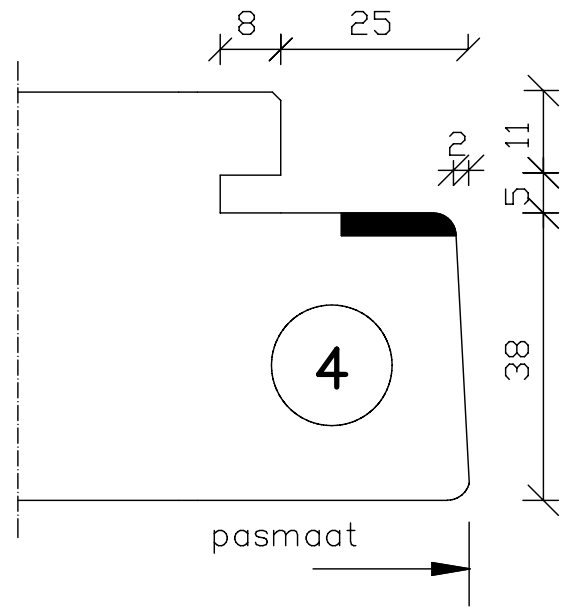
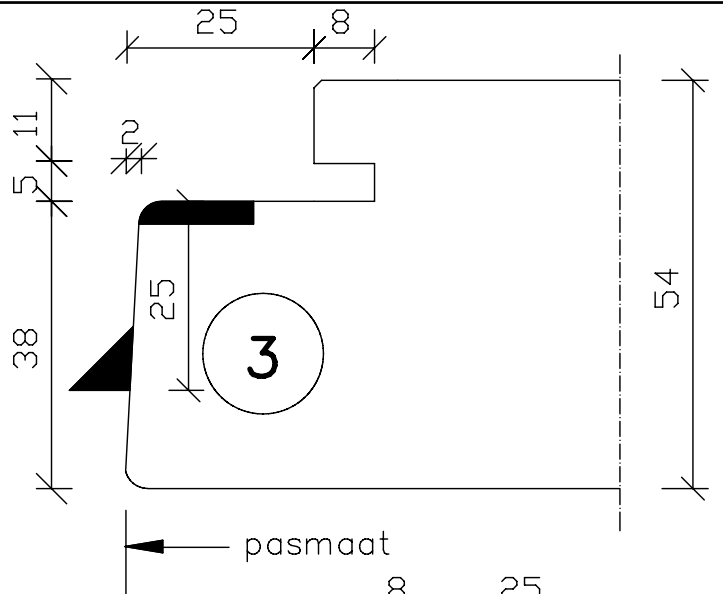
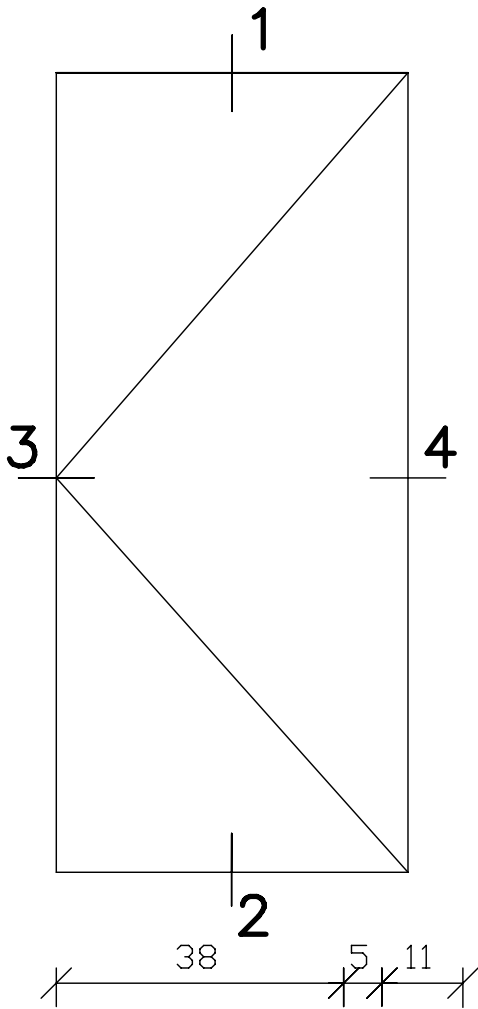

kaderprofiel: Deventer brandwerend
 Flexpress 2,5x15mm
 Interdens 2x20mm



	pas- en arm met kader, 54mm dik 60 min.brandw. naar buitendraaiend	Blad: 912 S
maten in mm		
okt. 2010		

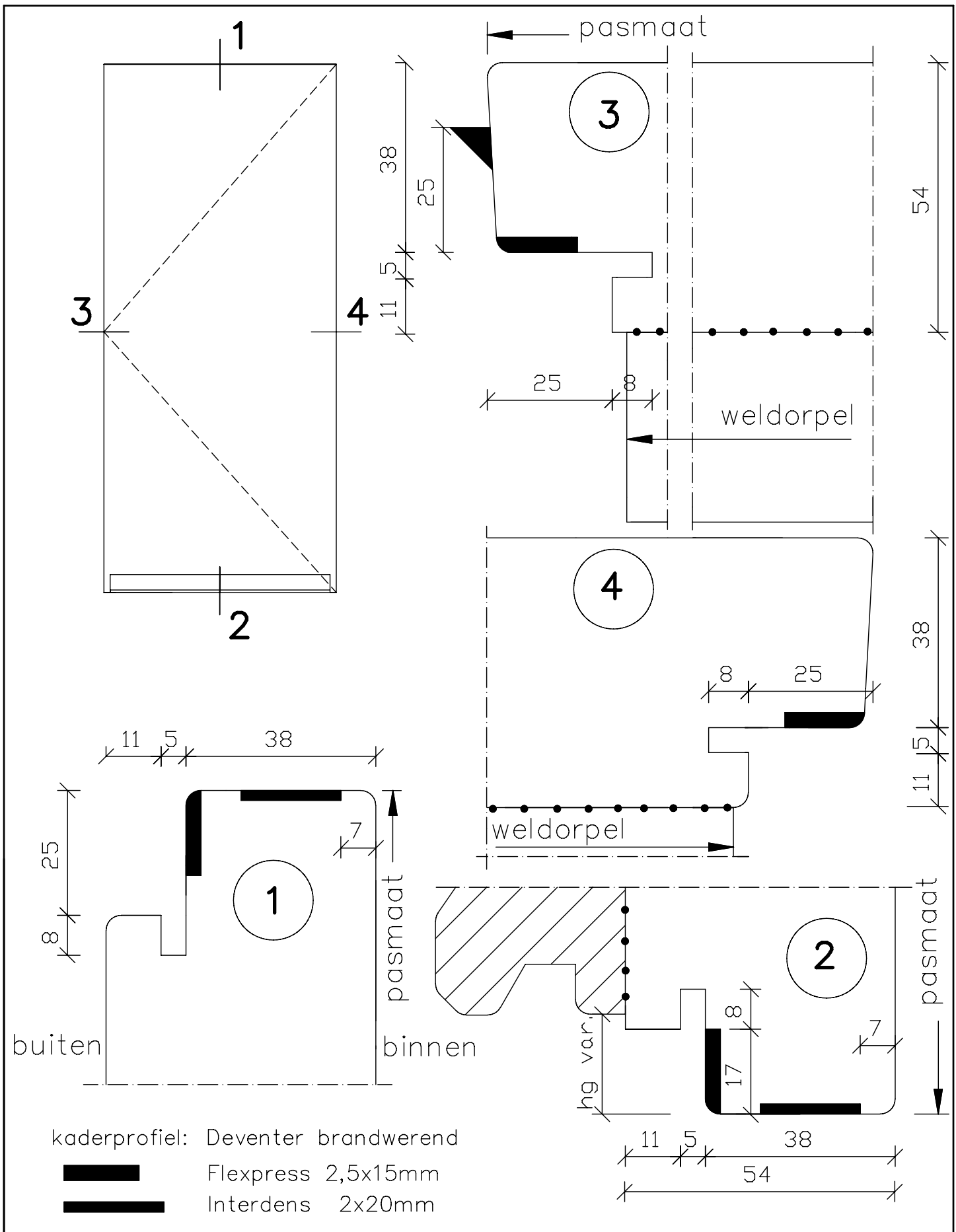

	pas- en arm met kader, 54mm dik 60 min.brandw. naar binnendraaiend	Blad: 920
maten in mm okt. 2010		

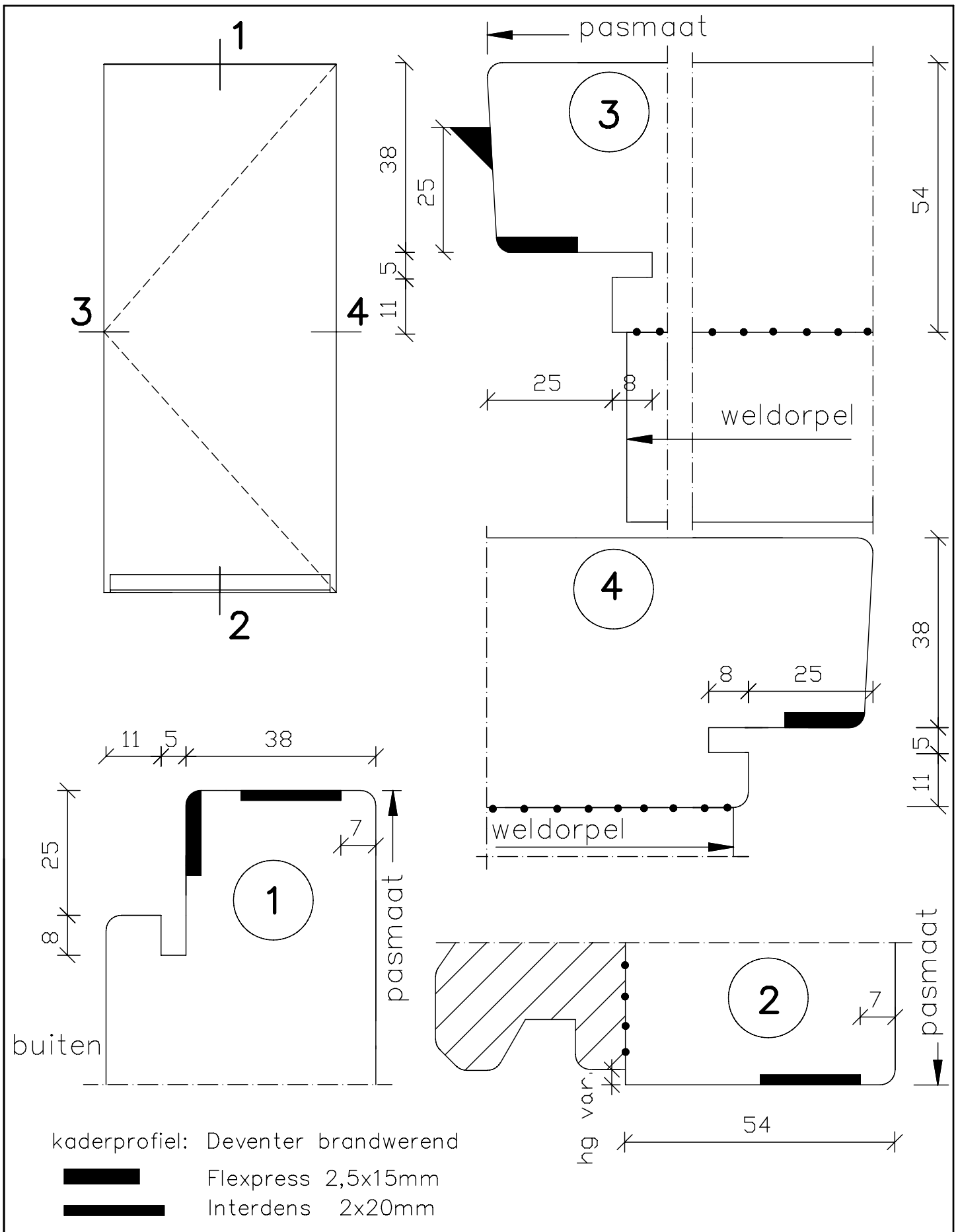

	pas- en arm met kader, 54mm dik 60 min.brandw. naar binnendraaiend	Blad: 920 S
maten in mm		
okt. 2010		