

**2512\***

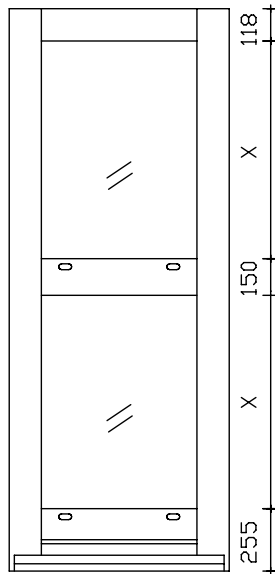

**2513\***

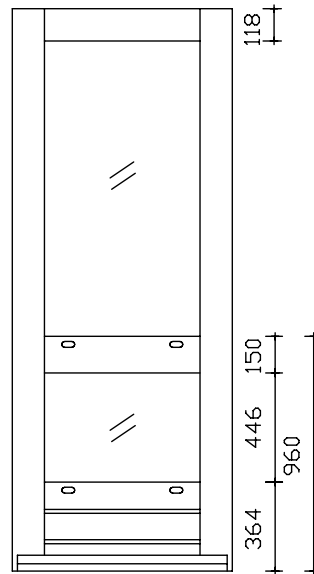

**2522\***

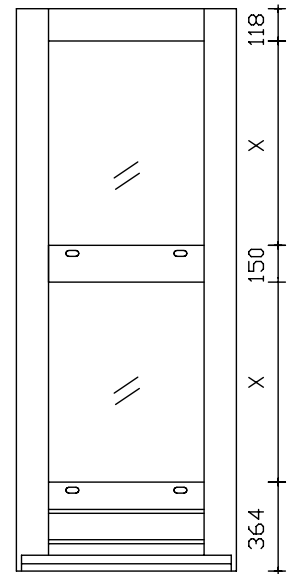

**2523\***

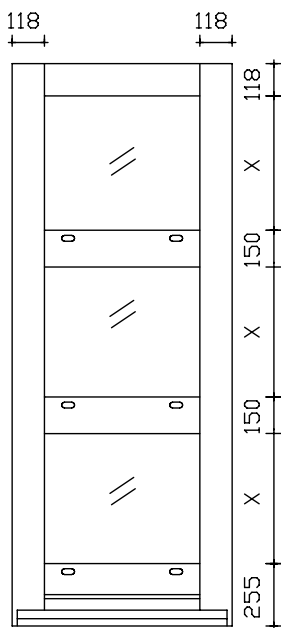

**2533\***

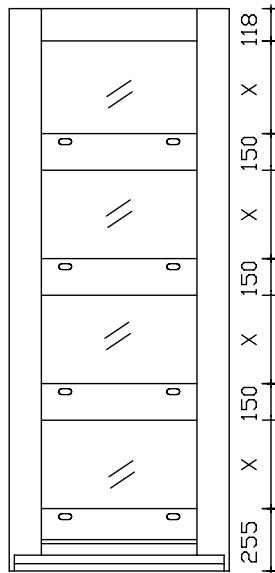

**2544\***

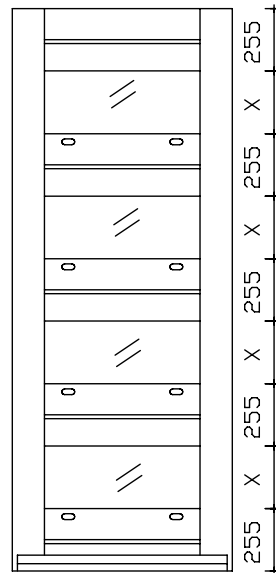

**2548**

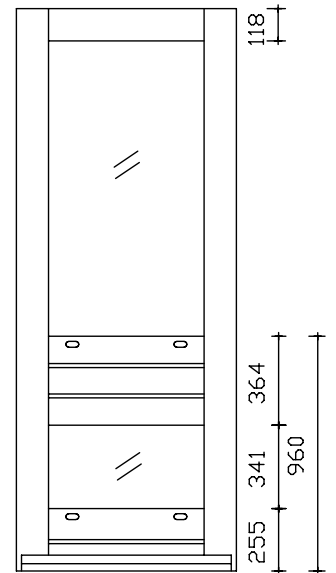

**2552**

\* = tussendorpel 150 ipv 132mm



maten in mm
okt. 2007

Voordeur-  
modellen

Blad:  
M  
1

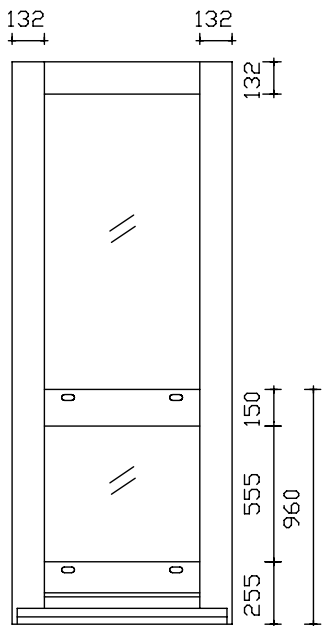

**2612\***

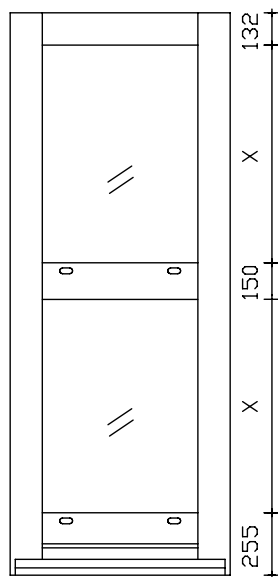

**2613\***

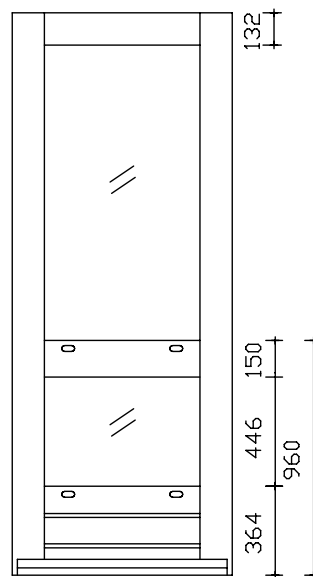

**2622\***

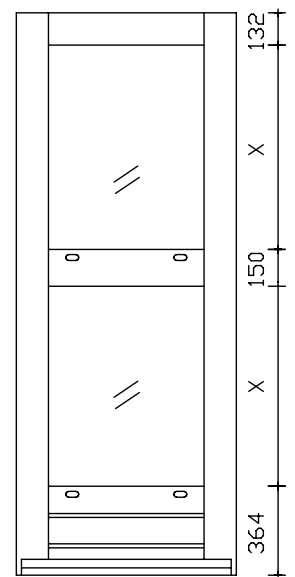

**2623\***

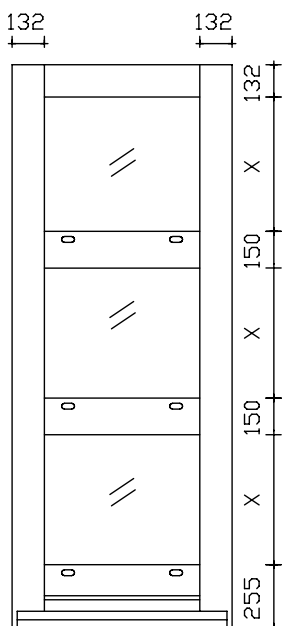

**2633\***

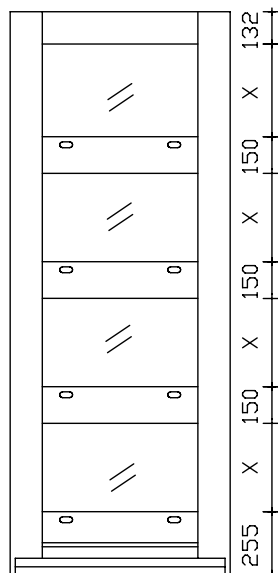

**2644\***

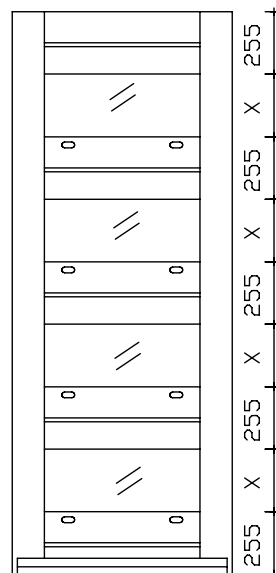

**2648**

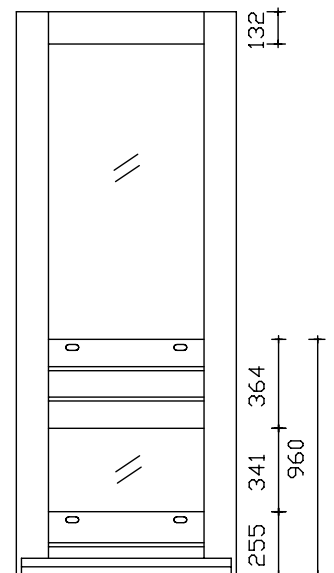

**2652**

\* = tussendorpel 150 ipv 132mm



maten  
in mm  
okt.  
2007

Voordeur-  
modellen

Blad:  
M  
2

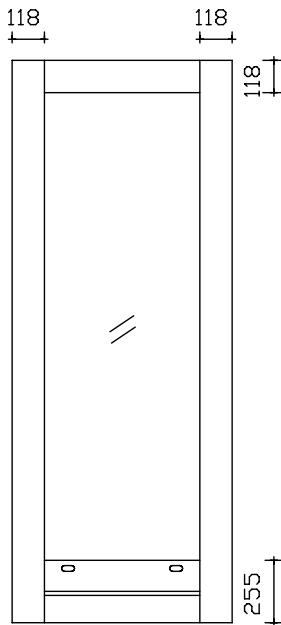

**5531**

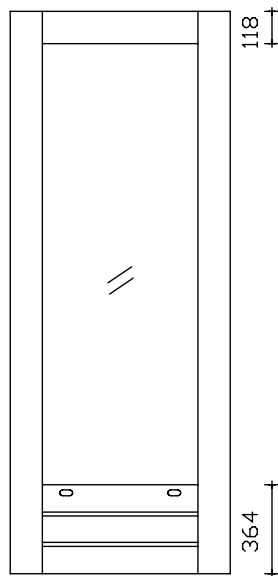

**5541**

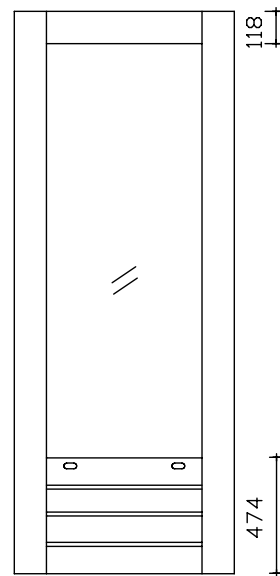

**5551**

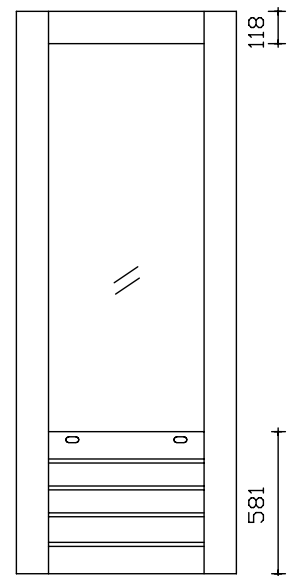

**5561**

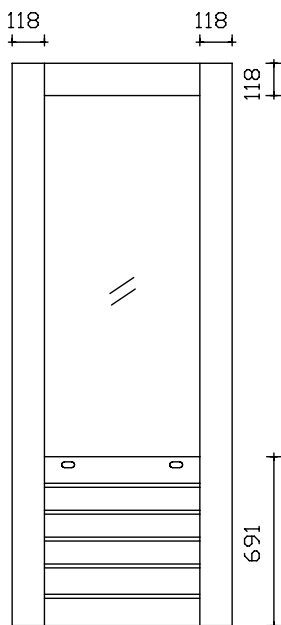

**5571**

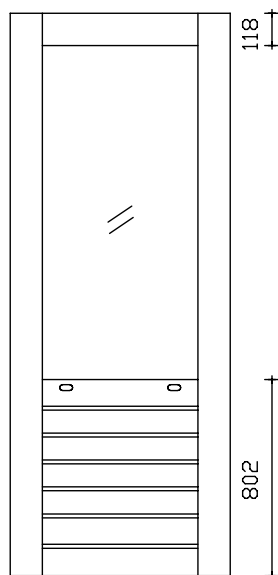

**5581**

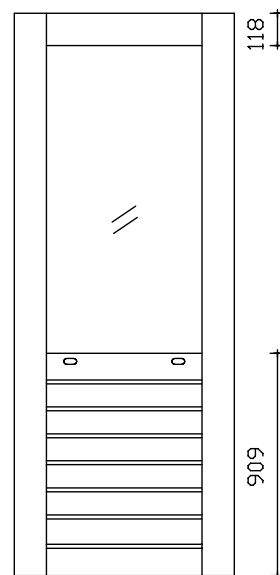

**5591**

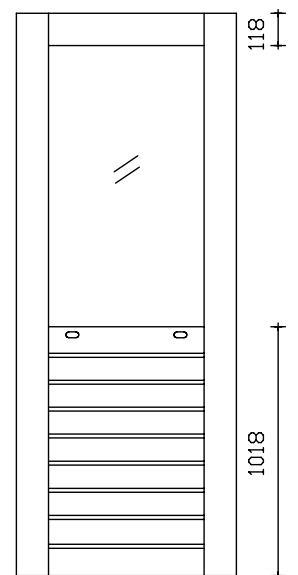

**5501**



maten in mm
mei 2006

Achterdeur-  
modellen

Blad:  
M  
3

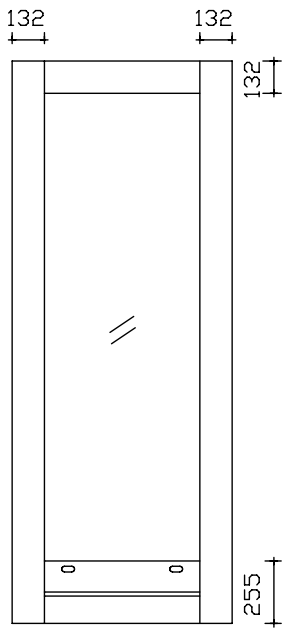

**5631**

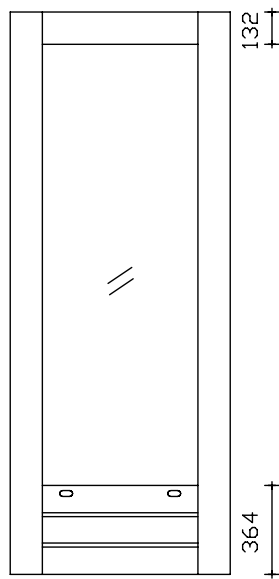

**5641**

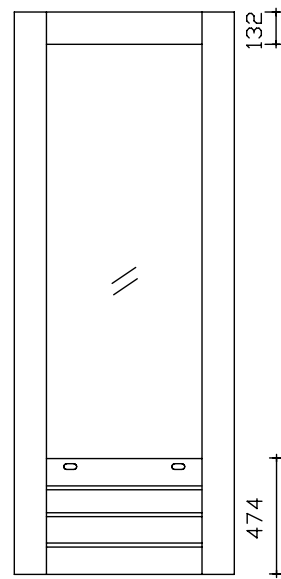

**5651**

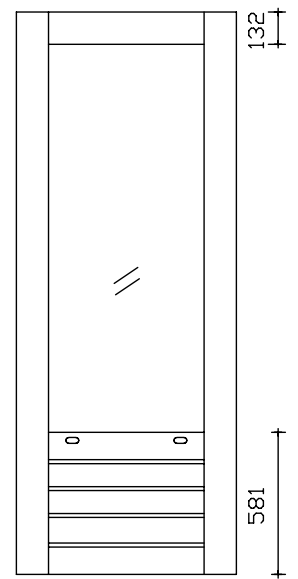

**5661**

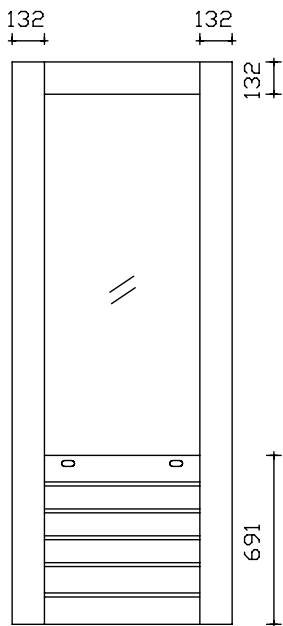

**5671**

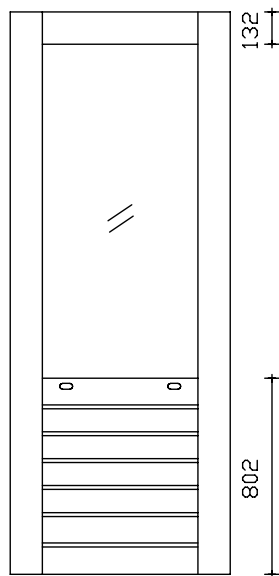

**5681**

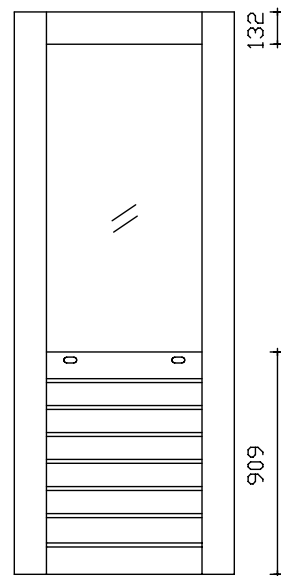

**5691**

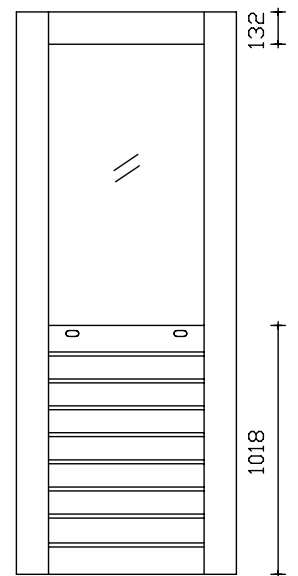

**5601**



**Deurenfabriek  
Suselbeek b.v.**

maten  
in mm

mei  
2006

Achterdeur-  
modellen

Blad:

**M  
4**

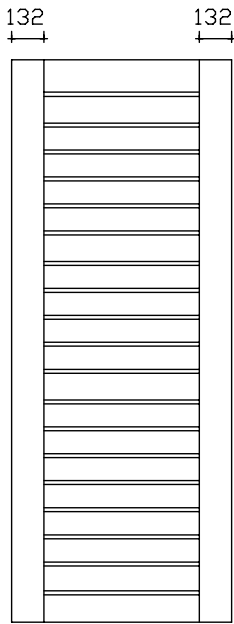

**5600**

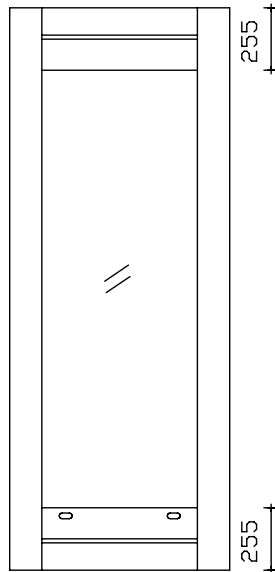

**5622**

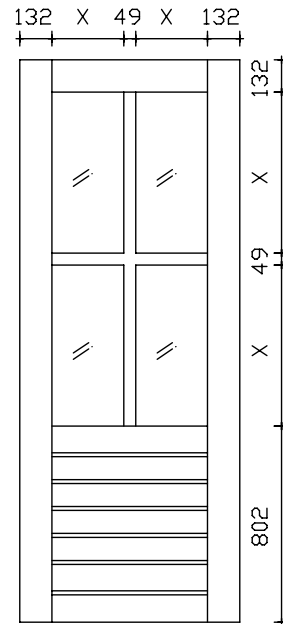

**5684**

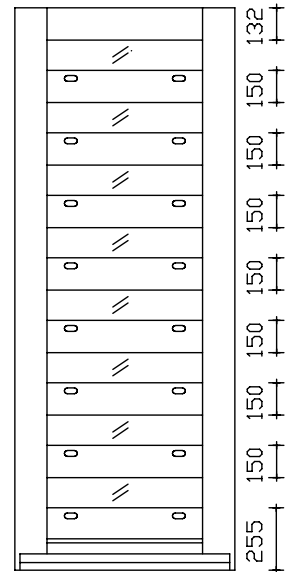

**2626\***

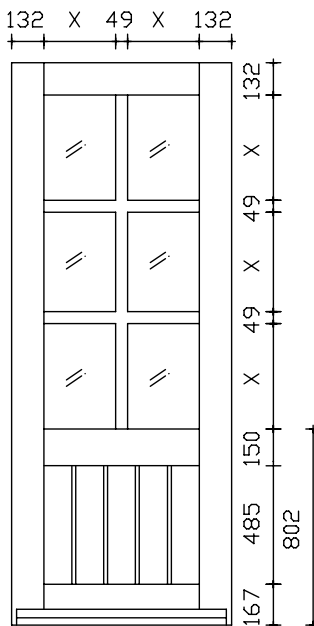

**2676\***

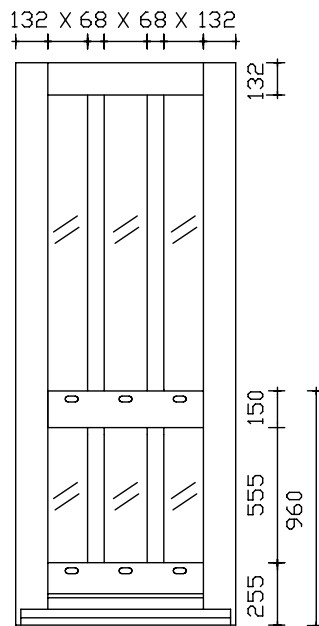

**2688\***

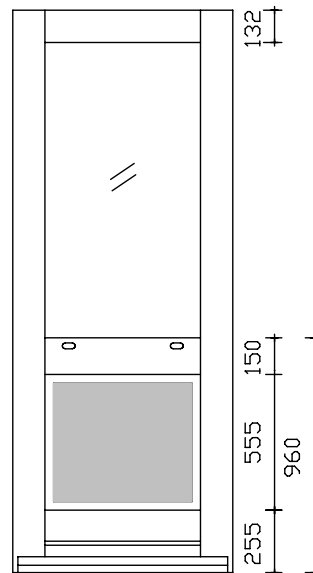

**2692\***

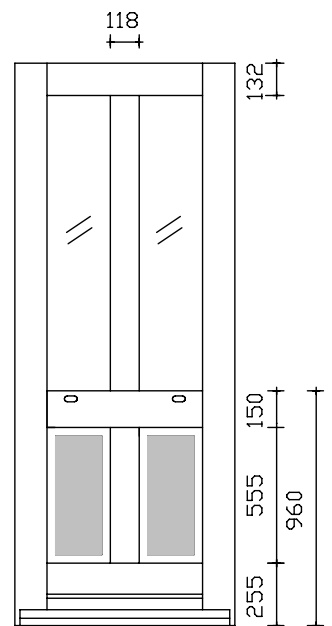

**2694\***

\* = tussendorpel 150 ipv 132mm



maten  
in mm  
okt.  
2007

Diverse  
modellen

Blad:  
M  
5

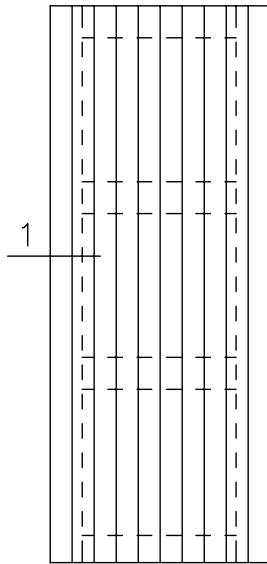

**4610**

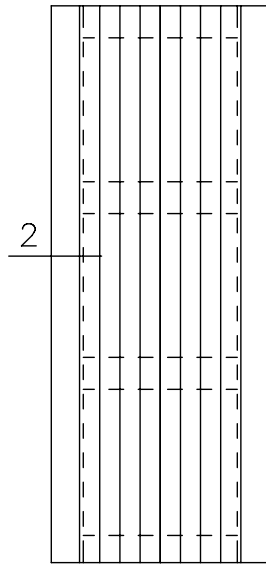

**4620**

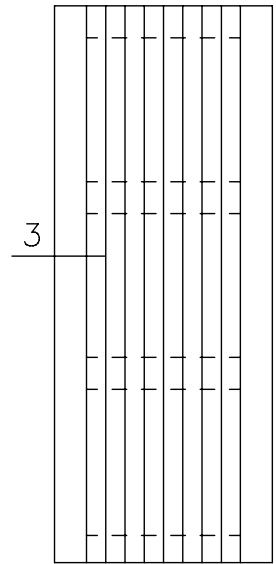

**4630**

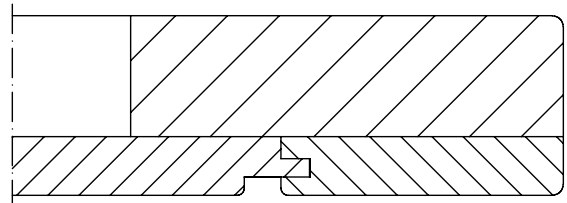
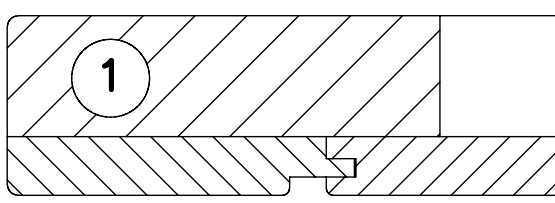

49

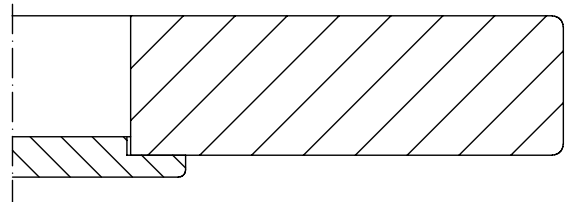
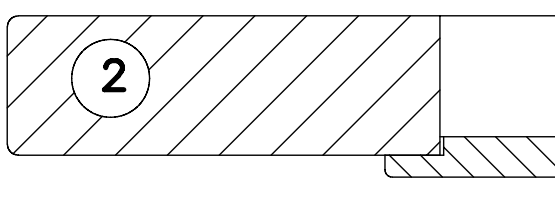

38

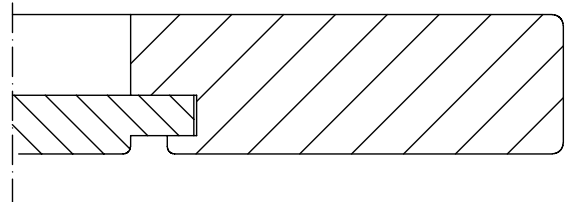
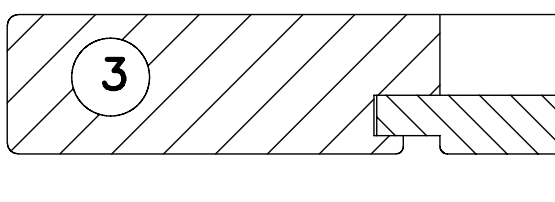

38



**Deurenfabriek  
Suselbeek b.v.**

maten  
in mm  
okt.  
2007

Achterdeur-  
modellen  
4600serie

Blad:  
**M**  
**6**